



**BOURDON**  
The Original by Baumer



## Main Features

- Excellent repeatability
- Dead band adjustment for regulation
- Fix dead band for control and alarm
- Intrinsic safety Hazardous area 0, 1, 2

## Applications

- Power generation safety equipment

## Technical Data

Temperature range	-46 ... 0°C to 40 ... 120°C
Temperature	Process : -46 ... +120°C Ambient : -30 ... +55°C Storage : -40 ... +55°C
Repeatability	± 1% F.S. @ constant temperature cycle
CE conformity	Low Voltage Directive LVD 2006/95/EC ATEX Directive 94/9/EC
Protection rating	IP 66 (EN 60529)
Process connection	RTA : Copper alloy RTN : Stainless steel 1.4404 (316L)
Bulb	RTA : Copper alloy RTN : Stainless steel 1.4404 (316L)
Scale	Internal. Accuracy on reading ± 5% FS
Cover	Zamak blue painted Captive stainless steel screws
Case	Black Zamak
Mounting	Direct mounting or with wall mounting bracket
Ground connection	Via internal terminal block
Electrical connection	Terminal block with plastic cable gland for Ø 7 to 10.5 mm

Electrical function	See ordering code details on page 5
Adjustment	2 external adjustment screws on top of the case for set point and dead band
ATEX	<u>Type examination certificate</u> LCIE 03 ATEX 6123X EN 60079-0 : 2009 EN 60079-11 : 2012 <u>Marking</u> CE 0081 Ex I M 1 Ex ia I Ma Ex II 1 G Ex ia IIC T6 or T5 Ga <u>Electrical data</u> U <sub>max</sub> = 28 Vdc I <sub>max</sub> = 120 mA P <sub>max</sub> = 0.84 W C <sub>i</sub> = Negligible ; L <sub>i</sub> = Negligible

## Options

Customer specific set point adjustment	Code SETP
Stainless steel tag plate and wire	Code 9941
Lead seal of the adjustment screws	Code 8990
Nuclear cleanliness (RTN only)	Code 0838
Electrical connection : stainless steel connector (Souriau)	Code 2298
Mobile plug for stainless steel connector (Souriau)	Code 2249

## Principle

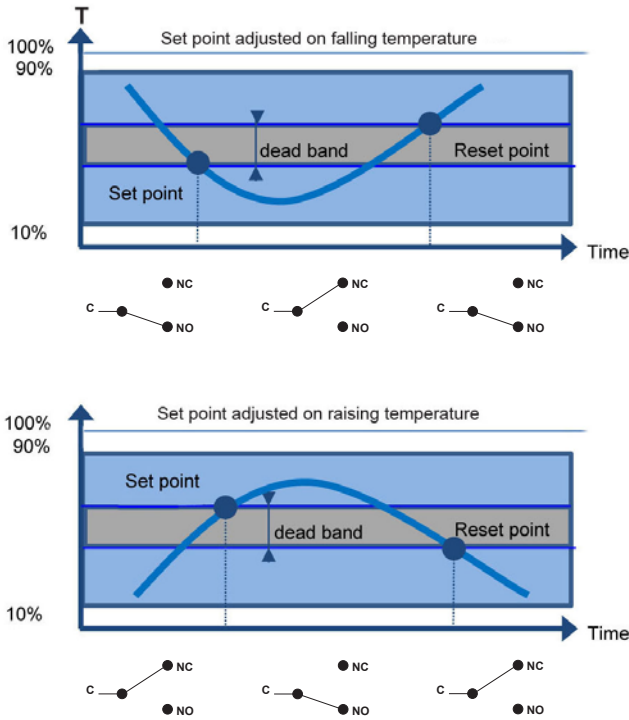

A vapour filled flexible sensing element actuates a microswitch by means of a lever. The set point is adjusted by means of a compressible spring installed in opposition.

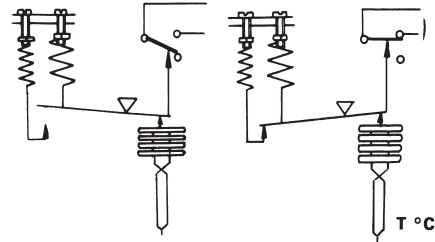

Set point and reset point must be between 10% and 90% of the selected scale.

### Standard factory adjustment

Setpoint at 50% of the scale on falling temperature

### Customer specific factory adjustment (option SETP)

The following specifications have to be given with the order:

- Setpoint value
- Adjustment on falling or raising temperature
- Dead band value when using an adjustable dead band switch

## Electrical connections

### 1 SPDT

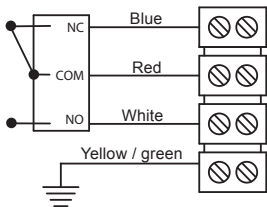

### 2 SPDT

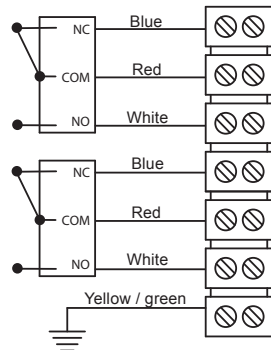

Hazardous area  
Zone 0, 1, 2

Certified safety  
barrier

Non hazardous  
area

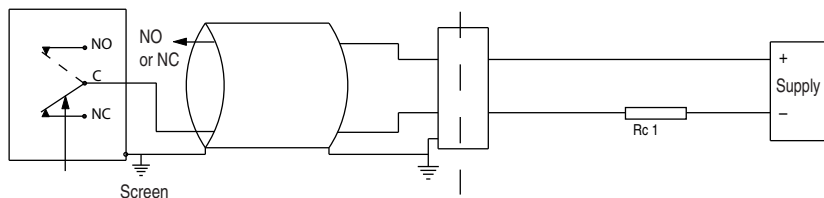

For max. ambient temperature refer to technical data on page 1.

The installation must be made in an intrinsically safe circuit whose certified electrical safety parameters do not exceed any of the values  $U_{max}$ ,  $I_{max}$  and  $P_{max}$  given in the electrical data on page 1.

All necessary measures must be taken by the user, to avoid the calorific transfer from the fluid to the apparatus head increasing the head's temperature to such that it reaches the self-ignition temperature of the gas in which it is used.

## Micro switches characteristics

Switch code	N (T)	M (K)	C (W)	S
Type	Tropicalized	Gold contact	Hermetic	Ultrasensitive Gold contact
6 Vdc	0.1 ... 0.12 A	10 ... 50 mA	5 ... 120 mA	10 ... 50 mA
12 Vdc	N/A	10 ... 50 mA	5 ... 66 mA	10 ... 50 mA
24 Vdc	N/A	10 ... 33 mA	5 ... 33 mA	10 ... 33 mA
30 Vdc	N/A	N/A	N/A	N/A
48 Vdc	N/A	N/A	N/A	N/A
110 Vdc	N/A	N/A	N/A	N/A
220 Vdc	N/A	N/A	N/A	N/A
115 Vac	N/A	N/A	N/A	N/A
250 Vac	N/A	N/A	N/A	N/A
Dielectric rigidity between contacts and ground	2000 V	2000 V	1500 V	2000 V

## Adjustable ranges

Scale	T <sub>Max</sub> accidental	Code	Micro-switch dead band <sup>1)</sup>							
			Adjustable dead band				Fixed dead band			
			N (T*)		M (K*)		C (W*)		S	
			10%	90%	10%	90%	10%	90%	10%	90%
°C		°C		°C						
-46 ... 0	40	<b>300</b>	4 - 9	2 - 9	8 - 12	4 - 12	3	2.5		
-20 ... 20	60	<b>301</b>	3 - 8	1.5 - 8	6 - 12	4 - 12	2.5	1.5		
0 ... 45	60	<b>302</b>	4 - 9	2 - 9	7 - 12	4 - 12	3	2		
40 ... 120	145	<b>303</b>	5 - 16	3 - 16	10 - 20	6 - 20	4	3.5		
20 ... 80	100	<b>315</b>	5 - 12	3 - 12	9 - 15	5 - 15	4	3		

(\*) For version with 2 microswitches lower values of the dead band must be multiplied x 1.5

<sup>1)</sup> The value of the dead band is depending on the value of the set point.

This table contains the dead band values for set point adjustment at 10% and 90% of the selected scale. For adjustable dead band the lower value corresponds to the dead band spring totally released and the higher corresponds to the dead band spring fully tensed. For other set points the dead band value can be calculated by linear interpolation between the values at 10% and 90%.

**Dimensions (mm)**

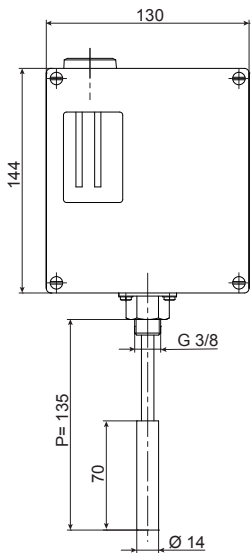
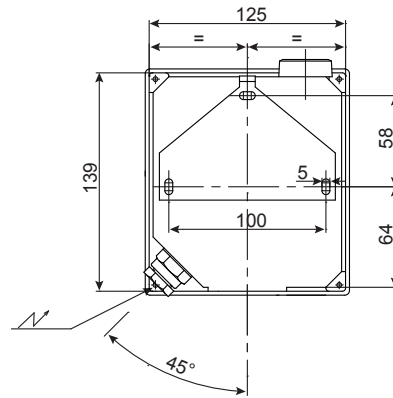
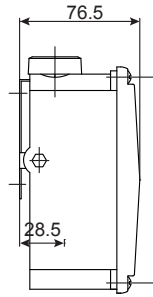
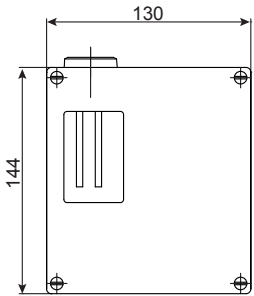

**Thermowell**  
Thermowell for RTxx3  
Stainless steel  
Ordering code : 10271317

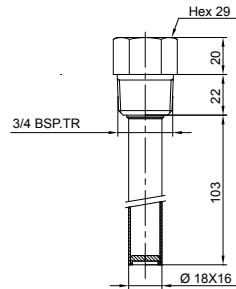

## Ordering details RTNY3-RTAY3

	RT	-	Y	.	3xx	.	E	0	0	E	J	/
<b>Model</b>	Industrial temperature switch											
<b>Type of the bulb</b>	Copper alloy bulb A Stainless steel bulb N											
<b>Approval</b>	ATEX intrinsic safety Y											
<b>Type of micro switches</b>	1 SPDT hermetically changeover switch C 2 SPDT hermetically changeover switch W 1 SPDT gold contact changeover switch M 2 SPDT gold contact changeover switch K 1 SPDT tropicalized changeover switch N 2 SPDT tropicalized changeover switch T 1 SPDT ultrasensitive gold contact changeover switch S											
<b>Temperature range (°C)</b>	-46 ... 0 300 -20 ... 20 301 0 ... 45 302 40 ... 120 303 20 ... 80 315											
<b>Type of design</b>	Direct mounting (TRD) E											
<b>Capillary length</b>	Without capillary 0											
<b>Stem length P</b>	P=135 mm 0											
<b>Bulb diameter</b>	Ø 14 mm E											
<b>Process connection</b>	G3/8 J											
Options to be added behind the / (see example below)												

## Ordering example with options

	RT	-	A	Y	C	.	300	.	E	0	0	E	J	/	SETP	_	9941
Industrial temperature switch	←																
Copper alloy bulb	←																
ATEX intrinsic safety	←																
1 SPDT standard changeover switch	←																
Temperature range -46 ... 0 °C	←																
TRD direct mounting	←																
Without capillary	←																
Immersion length P=135 mm	←																
Bulb diameter Ø 14mm	←																
Process connection G3/8	←																
Option : Customer specific set point adjustment	←																
Option : Stainless steel tag plate and wire	←																